

by ROADMASTER **BRAKEMASTER**TM

PROPORTIONATE TOWED CAR BRAKING SYSTEM

Second Vehicle Kit

Part number 98100

Installation Instructions



Time Tested • Time Proven

ROADMASTER, Inc. • 6110 NE 127th Ave. • Vancouver, WA 98682
• 800-669-9690 • Fax 360-735-9300 • roadmasterinc.com
851850-10 06/19 © 1999-2019 ROADMASTER, Inc. All rights reserved.

Welcome to the ROADMASTER family!

This manual has been prepared to acquaint you with the installation, operation, care and maintenance of your BrakeMaster, and to provide you with important safety information.

Read your owner's manual cover to cover. Understand how to install and operate your BrakeMaster, and carefully follow the instructions and safety precautions.

We thank you for your patronage and greatly appreciate your discerning taste.

Table of contents

Safety definitions	inside front cover
Before you begin the installation (installer's checklist)	1
Air cylinder assembly parts list.....	2
Install the seat bracket adapter.....	3
Install the air lines	3-4
Install the motorhome monitor wiring	5
Test the system	6-7
Brake light solutions	8
Install six diodes.....	9-10
Troubleshooting	11-13
Index.....	14

WARNING

These instructions pertain to the initial installation of the second vehicle components only. Operating instructions are contained in the owner's manual; installation instructions for the complete system are available at www.roadmasterinc.com.



Read all instructions before installing or operating the BrakeMaster system. Failure to understand how to properly install or operate BrakeMaster could result in property damage, personal injury or even death.

All illustrations and specifications contained herein are based on the latest information available at the time of publication. ROADMASTER, Inc. reserves the right to make changes, at any time, without notice, in material, specifications and models, or to discontinue models.

IMPORTANT NOTICE!

Safety Definitions

These instructions contain information that is very important to know and understand. This information is provided for **safety** and to **prevent equipment problems**. To help recognize this information, observe the following symbols:

WARNING

WARNING indicates a potentially hazardous situation which, if not avoided, could result in property damage, serious personal injury, or even death.

CAUTION

CAUTION indicates a potentially hazardous situation which, if not avoided, may result in property damage, or minor or moderate personal injury.

CAUTION

CAUTION used without the safety alert symbol indicates a potentially hazardous situation which, if not avoided, may result in property damage.

NOTE

Refers to important information and is placed in italic type. It is recommended that you take special notice of these items.

Before you begin the installation...

Note: this kit consists of the towed vehicle components only. The motorhome components of the BrakeMaster system must be installed and operating correctly for BrakeMaster to function.

1. A vehicle-specific seat adapter bracket is necessary to attach the BrakeMaster air cylinder to the floor of the towed vehicle. This bracket is not supplied with the kit; you must order it separately.

Rarely, a seat adapter bracket will not be available for a particular make and model of vehicle. In this case you must order a universal anchor plate kit (part number 450650-01). **Regardless of whether you use a seat adapter bracket or a universal anchor plate, you must have one or the other on hand before you begin the installation.**

To determine if a seat adapter bracket is available for your vehicle, go to www.roadmasterinc.com. Select 'Vehicle Specific Info,' then 'Supplemental Braking Systems.' Enter the motorhome and towed vehicle make, model and year, then scroll down the page.

2. If the battery must be disconnected for towing, a stop light switch must be installed. Stop light switch kits for a number of vehicles are available through ROADMASTER; to see if one is available for any specific vehicle, visit www.roadmasterinc.com and select 'Vehicle Specific Info,' then 'Supplemental Braking Systems.' Enter the vehicle make, model and year, then scroll down the page.

Note: if a stop light switch kit is listed on the web site for any particular vehicle, it is required.

Note: an Automatic Battery Disconnect (part number 765) is available for vehicles which must be towed with the battery disconnected.

If you choose to install the Automatic Battery Disconnect, a stop light switch is still required; a Brake-Lite Relay (see "Brake light solutions") is not required.

3. If the vehicle to be towed has an 'active' (or, 'continuous power assist') braking system, or if the vehicle is not equipped with power brakes – order the optional brake pressure reducer (part number 900002) to adapt the vehicle to the BrakeMaster system.

Vehicles with 'active' brake systems include several hybrid vehicles, such as the Ford Escape hybrid and the Mercury Mariner hybrid, as well as the H3 Hummer. These vehicles, and others with these systems, are designed so that even when the vehicle is set to 'tow' mode, the braking system is still active, thus requiring minimal pressure to engage the brakes.

CAUTION

If the vehicle to be towed has an 'active' braking system, or if the vehicle is not equipped with power brakes, install the optional brake pressure reducer.

If the reducer is not installed, BrakeMaster will apply excessive force to the towed vehicle's brake

pedal, causing severe tire and/or brake system damage, as well as other, consequential damage.

4. If fuse(s) must be removed from the vehicle before it can be towed – verify that removing the fuse(s) will not disrupt power to BrakeMaster, or otherwise affect the installation or operation.

(To eliminate pulling fuses to tow, purchase a FuseMaster. Information about this product is available at www.roadmasterinc.com)

5. Check the towed vehicle's brake lights – BrakeMaster must function with the ignition key turned to the "tow" position. However, some vehicles' brake lights only operate with the key turned to the "on" position.

Check to see if this is the case: turn the ignition key to the "tow" position, apply the brakes, and check to see if the brake lights illuminate. If the brake lights do not illuminate, a two-prong stop light switch and 10-amp fuse must be installed.

Stop light switch kits for a number of vehicles are available through ROADMASTER; to see if one is available for any specific vehicle, visit www.roadmasterinc.com and select 'Vehicle Specific Info,' then 'Supplemental Braking Systems.' Enter the vehicle make, model and year, then scroll down the page.

Note: check the owner's manual to see if the vehicle is equipped with an "automatic shut down" feature. If this is the case, ensure that the vehicle is not in automatic shut down mode before performing this test.

Note: if you must install a Brake-Lite Relay – see step 6, below – a stop light switch is not required.

6. An optional Brake-Lite Relay may be required. Refer to "Brake light solutions" for instructions on how to determine if the relay must be installed.

Note: a stop light switch (see steps 2 and 5 above) and a Brake-Lite Relay are mutually exclusive – if you use one, the other is not necessary.

AIR CYLINDER ASSEMBLY

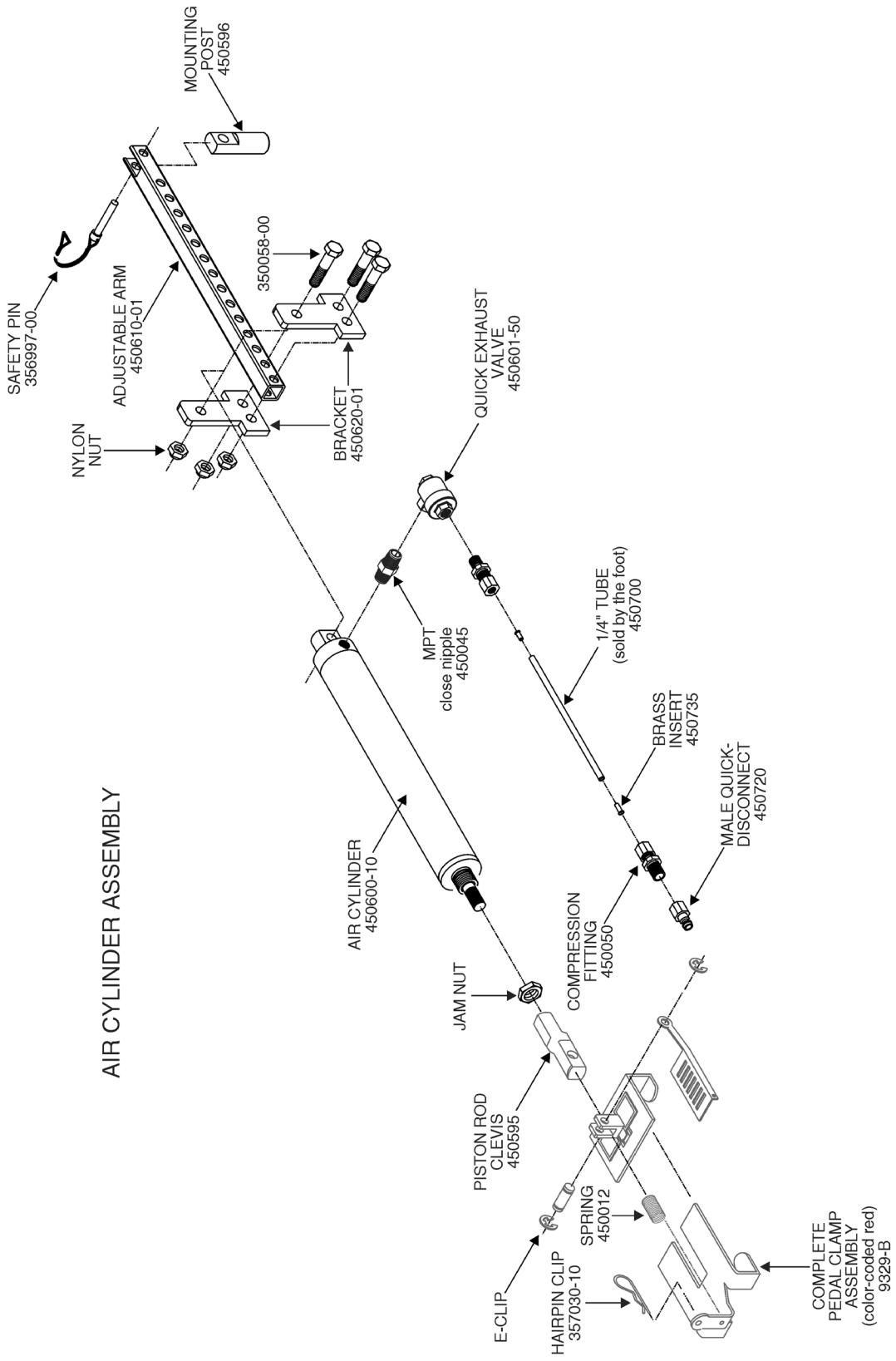

Install the seat bracket adapter (or air cylinder anchor plate)

1. A vehicle-specific seat adapter bracket is necessary to attach the BrakeMaster air cylinder to the floor of the towed vehicle. **This bracket is not supplied with the kit; you must order it separately.**

Rarely, a seat adapter bracket will not be available for a particular make and model of vehicle. In this case you must order a universal anchor plate kit (part number 450650-01). **Regardless of whether you use a seat adapter bracket or a universal anchor plate, you must install one or the other now.**

The installation instructions for both the seat adapter brackets and for the universal anchor plate are contained in the kits.

To determine if a seat adapter bracket is available for your vehicle, go to www.roadmasterinc.com. Select 'Vehicle Specific Info,' then 'Supplemental Braking Systems.' Enter the motorhome and towed vehicle make, model and year, then scroll down the page.

2. The BrakeMaster air cylinder will be in place after you have installed the seat bracket adapter. (For complete instructions on how to attach the air cylinder, refer to the BrakeMaster owner's manual.)

You can leave it in position until you have attached an air line fitting (step 7, "Install air lines in the towed vehicle") or you can remove it if it interferes with the installation.

Install the air lines

1. Find a suitable location at the front of the towed vehicle to attach the preassembled male quick coupler (Figure 1). Choose an area within easy reach, with a surface of sufficient strength to hold the mounting bracket firmly in place.

WARNING

Do not attach the female quick coupler at the front of the towed vehicle. The female quick coupler has an internal check valve to prevent air from escaping. If air pressure is not released, the BrakeMaster pedal clamp will not retract when the system is activated, which will cause severe brake system damage or a brake fire, as well as other consequential, non-warranty damage.

Failure to follow these instructions may cause property damage, personal injury or even death.

2. Attach the bracket with two of the supplied 1/4" nuts and bolts, with the male quick coupler pointing away from the towed vehicle.

Note: the weather covers will prevent dirt or debris from entering the lines. Keep the fittings covered when the braking system is not in use.

3. Connect one end of the air line to the male quick coupler compression fitting (Figure 1) – first, if neces-

sary, trim the end of the air line, to make a smooth and straight cut. Then slide the compression nut and the compression sleeve (Figure 1) over the air line.

Next, slide one of the brass inserts (Figure 1) onto the end of the line.

Note: if the brass inserts are omitted, the fittings will not be airtight.

Push the air line into the compression fitting, as far as it can go. Tighten the compression nut onto the fitting.

Note: if the compression nut is overtightened, the fitting will not be airtight. After completing the installation, check all the fittings for air leaks – see "Test the system."

4. Tape the open end of the air line. Then route the air line from the male quick coupler through the engine compartment and to the driver's side of the firewall. Avoid moving parts, sharp edges or "hot" components such as the engine or the exhaust system. Do not kink the air line, or bend it to the extent that it crimps or creases. Where appropriate, use wire ties to secure the air line in place.

CAUTION

Do not position the air line closer than two feet from any heat source. The heat will soften the plastic, which will cause the air line to rupture.

If the air line is ruptured, the supplemental braking system will not function.

Do not kink the air line, or bend it to the extent that it crimps or creases – air pressure will be substantially reduced, or blocked entirely, at the kink in the line.

If the air pressure is reduced, the supplemental braking system will not function, or may only function intermittently.

5. Next, look for a pre-existing hole in the firewall (or, if there is sufficient space, a pre-existing wiring grom-

continued on next page

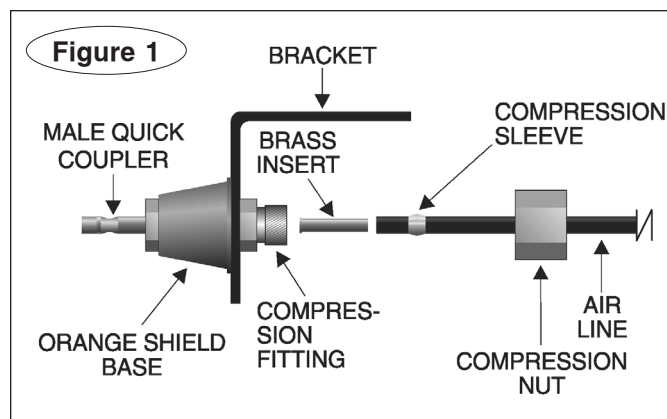

Install the air lines

continued from preceding page

met) on the driver's side, to route the air line through the firewall.

If there is no pre-existing hole or grommet with sufficient space, drill a ½" hole through the firewall.

Drill from the engine compartment or from the interior of the vehicle, whichever is more convenient. Before drilling, make certain you will not damage any components on the other side of the firewall.

6. Fit the included firewall grommet into the ½" hole, and push the end of the air line through.

7. The air line will be connected to the preassembled female quick coupler (Figure 2) –

Find a likely mounting point for the bracket on the driver's side – choose an area within easy reach, with a surface of sufficient strength to hold the mounting bracket firmly in place.

The bracket and quick coupler must not present an obstacle or hazard to the driver of the vehicle, or otherwise interfere with the operation of the vehicle.

Two common mounting points are: 1) under the dashboard, on the kick panel; or 2) far enough under the front of the driver's seat so that the quick coupler is accessible when the seat is slid back, but concealed when the seat is slid forward.

Or, depending on the interior design of the vehicle, there may be a more suitable mounting point.

Before attaching the bracket, first connect the BrakeMaster air cylinder assembly. Make certain that the male quick coupler at the end of the air line will reach the point you have chosen to attach the female quick coupler, without kinking either of the air lines.

Note: the quick exhaust valve on the air cylinder (see page 2) may be rotated, if this provides an easier connection.

Before attaching the coupler, make certain you will not damage any components on the other side.

If you have chosen to attach the bracket under the driver's seat, make certain that the female quick coupler and bracket will not interfere with the normal movement of the driver's seat, or affect any adjustments to the driver's seat.

- If you have chosen to attach the bracket to the kick panel, attach it with two of the supplied ¼" nuts and bolts, with the female quick coupler pointing toward the rear of the towed vehicle.

- If you have chosen to attach the bracket under the driver's seat, route the air line from the firewall to the front edge of the driver's seat. Remove the rocker panel or side trim (or, detach the carpeting) and conceal the air line underneath it.

Move the driver's seat back as far as it will go.

Attach the bracket with two of the supplied ¼" nuts and bolts, with the female quick coupler pointing toward the front of the vehicle.

8. Cut the air line to length and attach it to the compression fitting on the female quick coupler. Use the

same method described in step 3 (above) to attach the air line.

9. Seal the firewall grommet with a silicone sealant. Reattach the rocker panel (or side trim or carpeting), if it was removed.

Note: the weather covers will prevent dirt or debris from entering the lines. Keep the fittings covered when the braking system is not in use.

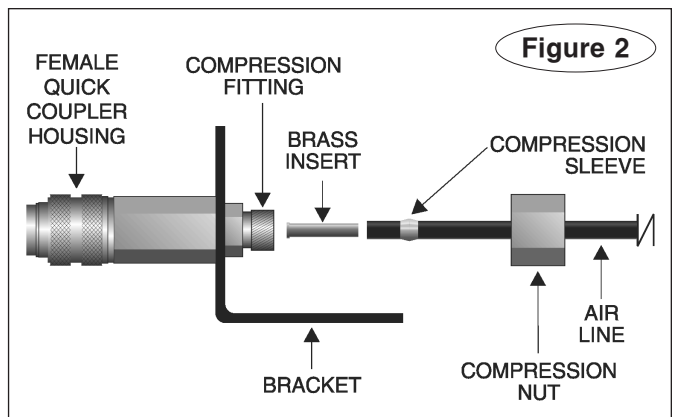

Install the motorhome monitor wiring

1. Choose a mounting point at the front of the vehicle near the male quick coupler you attached in step 2, “Install the air lines,” for the end of the supplied length of black wire with a female bullet connector at one end. Attach the connector with one or more of the included wire ties. Allow enough slack so that a male bullet connector can be plugged into and out of it.

2. Once the female bullet connector is attached, route the monitor wiring harness through the engine compartment, to the driver’s side of the firewall. Use the same route as the air line, if that is convenient. As before, avoid lines, hoses, moving parts or “hot” components such as the engine or exhaust systems. Where appropriate, use wire ties to secure the wiring harness in place.

3. Route the monitor wiring harness through the same hole as the air line.

4. Before connecting the monitor wiring harness to the brake light wire, determine if the optional Brake-Lite Relay must be installed – refer to “Brake light solutions,” in these instructions, for information on how to identify the type of brake and turn signals in the vehicle. Then test the towed vehicle’s brake lights, as described in “Brake light solutions.”

Several wiring alternatives are available to you, based on the type of brake and turn signals in the vehicle and the results of the test.

5. Next, locate the towed vehicle’s brake light switch and, with a test light, find the “cold” side of the brake light switch. (The “cold” side of the switch does not register voltage unless the brakes are applied.) With a 12-volt meter, verify that you have found 12 VDC+.

Then, remove the vehicle’s brake light fuse, located in the vehicle’s fuse panel.

CAUTION

Failure to remove the brake light fuse from the vehicle’s fuse panel may cause the vehicle’s theft deterrent system, or other electrical system indicators, to be activated if the brake pedal is depressed during the installation. This may require non-warranty repair to the vehicle.

6. Cut the brake light wire, a few inches downstream from the “cold” side of the brake light switch.

If the Brake-Lite Relay is required...

(see step 4, above)

Install the Brake-Lite Relay now – installation instructions are included in the kit. After the relay is installed, proceed to the next section – “Test the system.”

If the Brake-Lite Relay is not required...

(see step 4, above)

7. If necessary, trim the monitor wiring harness, then attach the monitor wire to the brake light wire, using the supplied yellow butt connector.

8. Ensure that the monitor wiring harness will not present an obstacle or hazard to the driver of the vehicle, or interfere with the operation of the vehicle. Use one or more wire ties, if necessary, to secure the wiring harness out of the way.

9. Reinstall the brake light fuse, which you removed in step 5.

10. The installation is complete. Before towing, proceed to the next section – “Test the system.”

Test the system

Note: this kit consists of the towed vehicle components only. In order to complete the system test, the motorhome components must be installed and operating correctly for BrakeMaster to function.

Note: refer to the complete installation instructions to identify the motorhome components you will connect. The most current version of the instructions is available at www.roadmasterinc.com.

CAUTION

Always deplete the stored vacuum in the towed vehicle's power brake system before towing – pump the brake pedal several times.

Depending on the make and model of the towed vehicle, it may be necessary to pump the brake pedal repeatedly to deplete the vacuum.

If the vacuum is not released, the supplemental braking system will apply excessive braking force when it is activated, which will cause severe tire and/or brake system damage to the towed vehicle.

1. The motorhome and towed vehicle must be stationary for the system test, and ready for towing.

A. All components of the braking system must be properly connected –

- Connect and attach the tow bar to both vehicles.

Then, according to the manufacturer, make all adjustments necessary to prepare the vehicle for towing. These adjustments may include: turning the ignition key to the “tow” position; pulling fuses; disconnecting the battery; and setting the transmission to a particular gear or in a particular sequence.

Refer to the owner's manual or call the dealership for vehicle-specific information.

CAUTION

To prevent the towed vehicle from rolling, connect and attach the tow bar to both vehicles before shifting the towed vehicle's transmission into the proper gear for towing.

- Connect the patch cord between the two vehicles – both the air line quick couplers and the motorhome monitor bullet connectors.

- Attach the air cylinder to the brake pedal and mounting post (or seat bracket adapter). Connect the male quick coupler at the end of the air line on the air cylinder to the female quick coupler at the end of the air line mounted in the passenger compartment.

B. For motorhomes with hydraulic brakes (BrakeMaster 9060): turn the motorhome engine on, and leave it running. Turn the towed vehicle's ignition key to the “tow” position.

For motorhomes with air or air over hydraulic brakes (BrakeMaster 9100 and 9160): block the motorhome wheels, then release the parking brake. Turn the

motorhome engine on, and leave it running.

2. Check for leaks in the towed vehicle's air line: allow the air compressor to run until it shuts off. Then apply the motorhome brakes and continue to hold the brake pedal down.

Cover each joint, fitting and connection in the towed vehicle's air line with a leak check solution.

CAUTION

The air system now contains pressurized air, which may cause severe eye or ear injury if it is inadvertently released. Wear appropriate eye and ear protection before adjusting the air system connections and fittings.

Tighten any fittings, if necessary, and repeat until all connections are airtight.

3. Confirm the proper operation of the braking system: depress and hold the motorhome brake pedal down. At the towed vehicle, the air cylinder shaft and pedal clamp will extend. Then, release the brake pedal. The air cylinder shaft and pedal clamp will retract.

4. Confirm that the motorhome monitor is functioning: the LED will illuminate after the motorhome brake pedal is depressed, and stop illuminating when the brake pedal is released.

WARNING

If the LED does not illuminate, as described above, identify and correct the cause of the malfunction before using the supplemental braking system. Refer to the Troubleshooting section for possible causes.

The LED is the only indication of braking activity at the motorhome. Severe damage to the towed vehicle, a loss of vehicular control or other consequential, non-warranty damage can occur if the driver of the motorhome is unaware that the supplemental braking system is not functioning properly.

Failure to follow these instructions may cause property damage, personal injury or even death.

5. Confirm the proper operation of the towed vehicle's brake lights and turn signals –

A. Depress the motorhome brake pedal; confirm that the towed vehicle's brake lights illuminate. Activate both motorhome turn signals; confirm that the towed vehicle's turn signals activate.

If the towed vehicle's brake lights and turn signals do not operate in tandem with the motorhome, you must install a non-intrusive lighting system or re-wire the towed vehicle. See “Brake light solutions.”

B. With one of the motorhome turn signals activated, depress the motorhome brake pedal. Confirm that the towed vehicle's brake lights and turn signal

continued on next page

Test the system

continued from preceding page
both illuminate.

If the towed vehicle's brake lights override the turn signal, you must install a non-intrusive lighting system or re-wire the towed vehicle. See "Brake light solutions."



WARNING

By law, a towed vehicle's turn signals and brake lights must operate in tandem with the motorhome's, as described above. If they do not, drivers behind the towed vehicle will not be alerted when the motorhome stops or turns, which may cause a collision.

If the towed vehicle's brake lights and turn signals do not operate in tandem with the motorhome, either install a non-intrusive lighting system or re-wire the towed vehicle according to the next section, "Brake light solutions." Then test for proper operation, as described in step 5, above.

Failure to follow these instructions may cause property damage, personal injury or even death.

Brake light solutions

A supplemental braking system will affect the operation of the vehicle's tow lighting system. Use the information below to determine if optional components must be installed in a vehicle which has been wired for towing – or, if no lighting system has been installed, which systems are appropriate.

1. First, identify the type of brake and turn signals in the vehicle. There are two types – combined or separate. In a **combined** system (Figure 3), the brake light does the flashing for the turn signal; in a **separate** system (Figure 3), there are amber or red turn signal lights which are separate from the brake lights.

2. Next, test to see if the towed vehicle's brake lights will illuminate with the engine off – with the ignition key at the "tow" position, press the brake pedal and check the brake lights.

3. Based on whether or not the brake lights illuminate, and the type of brake and turn signals, there are three possibilities:

- the brake lights illuminate and the towed vehicle has combined lighting;
- the brake lights illuminate and the towed vehicle has separate lighting; or
- the brake lights do not illuminate.

There are a number of lighting methods available for each of these three possibilities; they are described below.

(If you choose to install a Universal Wiring Kit, a bulb and socket kit, magnetic tow lights or the Brake-Lite Relay, complete installation instructions and wiring diagrams are included with the kits; this information is also available online at www.roadmasterinc.com.)

If the brake lights illuminate and the towed vehicle has combined lighting...

...one of the three alternatives below is required:

- A Universal Wiring Kit (part number 154) **with** a Brake-Lite Relay – a system of diodes is installed to rewire the vehicle's turn signals, taillights and brake

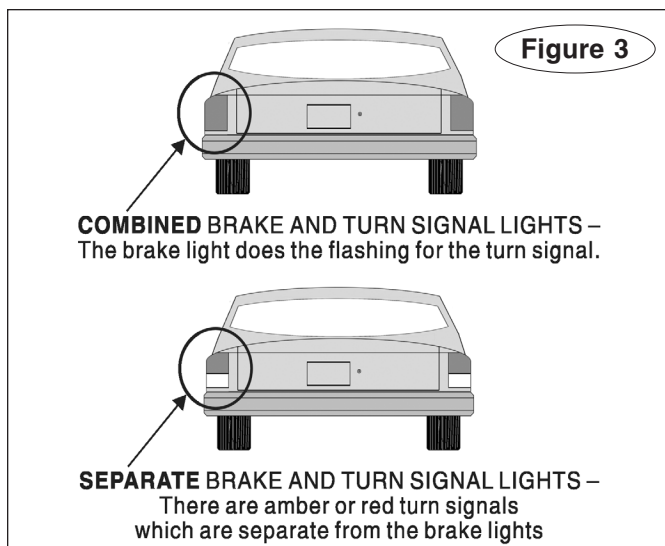

lights for towing.

- Install an optional bulb and socket set (also called a "taillight wiring kit," part number 155).
- Install an optional magnetic tow light system (part number 2100 or 2120).

If the brake lights illuminate and the towed vehicle has separate lighting...

...one of the four alternatives below is required:

- A Universal Wiring Kit (part number 154) **with** a Brake-Lite Relay – a system of diodes is installed to rewire the vehicle's turn signals, taillights and brake lights for towing.
- Install six diodes, and jump the diodes. See page 9.
- Install an optional bulb and socket set (also called a "taillight wiring kit," part number 155).
- Install an optional magnetic tow light system (part number 2100 or 2120).

If the brake lights do not illuminate...

...an optional stop light switch **must** be installed. Stop light switch kits for many vehicles are available through ROADMASTER; visit www.roadmasterinc.com for the most current list.

Any one of the following tow lighting systems must also be installed with the stop light switch:

- A Universal Wiring Kit (part number 154) – a system of diodes is installed to rewire the vehicle's turn signals, taillights and brake lights for towing.
- An optional bulb and socket set (also called a "tail-light wiring kit," part number 155)
- An optional magnetic tow light system (part number 2100 or 2120)

Install six diodes

Note: this wiring method can only be used if the brake lights illuminate with the engine off and the towed vehicle has separate lighting. See page 8.

Note: if the motorhome has combined brake and turn signals, use Figure 4 to wire the towed vehicle. If the motorhome has separate brake and turn signals, visit www.roadmasterinc.com. Use the 'Separate towed vehicle to separate motorhome' wiring diagram under 'Support.'

Note: if a 3-to-2 converter has been installed in a motorhome with separate brake and turn signals, wire the towed vehicle according to Figure 4.

To test for a 3-to-2 converter, use a test light to find the turn signal and brake light circuits on the motorhome electrical socket. If the same circuit energizes both the turn signals and the brake lights, a 3-to-2 converter has been installed. If the turn signal and brake lights have separate circuits, a 3-to-2 converter has not been installed.

1. Cut the factory turn signal, taillight and brake light wires, as close to the lights as possible.
2. Install the six diodes in line, as shown in Figure 4. Install the diodes as close to the lights as possible.

CAUTION

Attach the diodes as close to the vehicle's

lights as possible, to avoid interaction with other circuits which may be tied into the center brake light, the running lights, the turn signals or the brake light wires.

Attaching the diodes farther away may cause the towed vehicle's lights to work improperly and may also cause damage to other electrical components in the vehicle.

3. On each side, jump the brake and turn signal diodes, as shown in Figure 4.

CAUTION

Unless the brake and turn signal diodes are jumped, the towed vehicle's brake light circuits will override the motorhome's turn signals – the towed vehicle's turn signals will not operate in conjunction with the motorhome's turn signals, as required by law.

4. Test the installation...
 - A. If the motorhome has a combined lighting system (Figure 3)...

1. The towed vehicle's turn signals and brake lights will both flash (each side) when the motorhome's

continued on next page

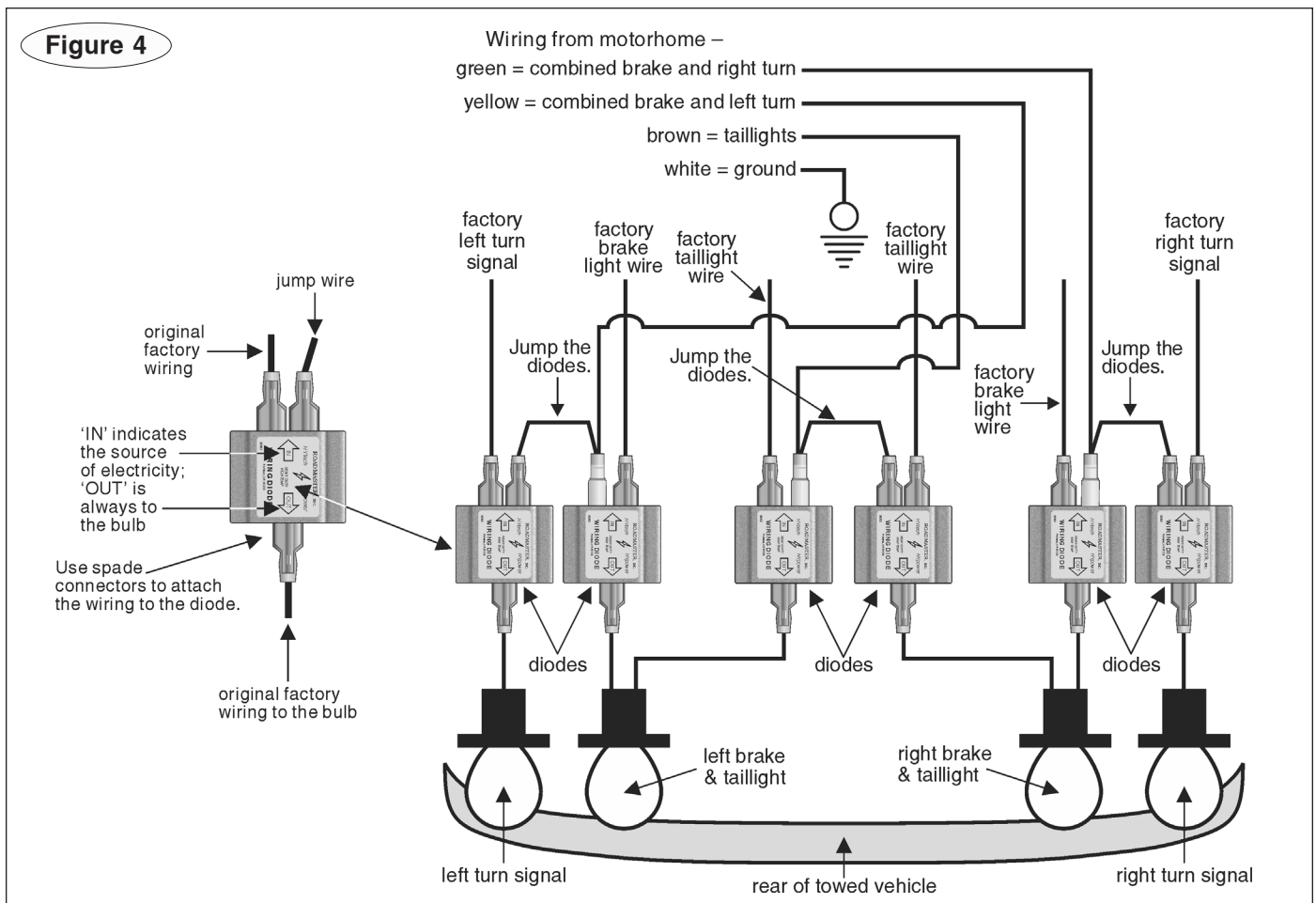

Install six diodes

continued from preceding page

turn signal is on; and

2. When the motorhome's turn signal and brake signal are both on (each side), the towed vehicle's brake lights will stay illuminated, while the turn signal flashes.

B. If the motorhome has a separate lighting system (Figure 3), the towed vehicle's turn signals and brake lights will illuminate identically to the motorhome's.

Troubleshooting

Symptom

The motorhome monitor LED does not illuminate, even though the brakes in the towed vehicle are being applied.

Solution

1. The monitor LED will not illuminate during very light braking.
2. Make certain that the monitor patch cord is securely connected between the two vehicles.
3. The towed vehicle-to-motorhome electrical cord must also be connected – the monitor system uses it for the ground wire.
4. The monitor LED is connected to the towed vehicle's brake light circuit. If the fuse in the circuit is blown, the LED will not illuminate. Check the towed vehicle's brake lights – if they illuminate when the brake pedal is depressed, the fuse is good.
5. Did you install the optional Brake-Lite Relay? If so, make certain that the monitor wire is connected to the towed vehicle's brake light wire **after** the brake light switch, but **before** the Brake-Lite Relay – connecting the wire anywhere else will prevent the monitor LED from functioning.

Symptom

Nothing happens after proper installation.

Solution

1. The motorhome engine must be running – if the engine is off, there may be insufficient pressure to activate BrakeMaster.
2. Check the air line connections. Remove the weather covers from the quick couplers at both vehicles, and gently tug on the air line to verify that the quick couplers are connected.
Check to make certain that the air cylinder quick coupler is connected to the air line in the passenger compartment.
3. For motorhomes with hydraulic brakes (BrakeMaster 9060) –

A. Check the wiring at the solenoid valve (on the proportioning valve). One of the black wires must be connected to a good chassis ground (Figure 5). The other black wire must be connected to the motorhome brake wire downstream from the brake light switch. Use a test light to confirm that the solenoid valve is receiving power when the motorhome brake pedal is depressed.

If the connections are good, test for proper function – with the motorhome engine running, have an assistant depress the motorhome brake pedal while you listen for a “click” at the solenoid valve. The solenoid valve should “click” every time the brake pedal is depressed.

B. Disconnect the air line from the “out” compression fitting on the solenoid valve (Figure 5). Have an assistant depress the motorhome brake pedal – the proportioning valve should release air each time the pedal is depressed.

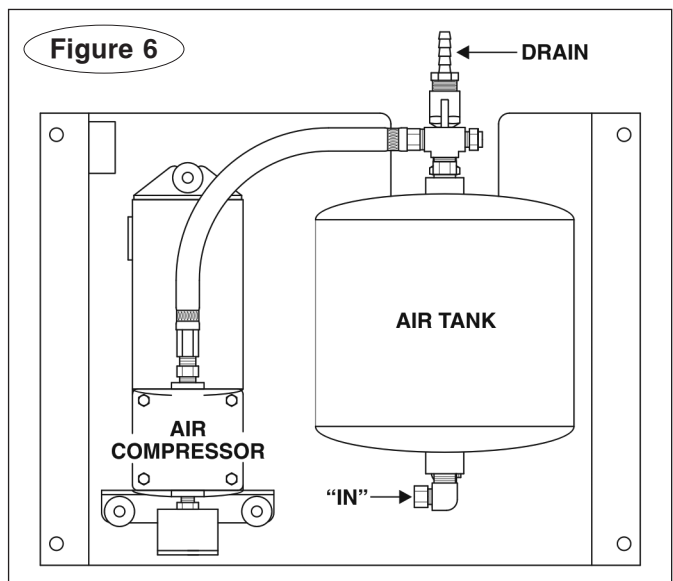
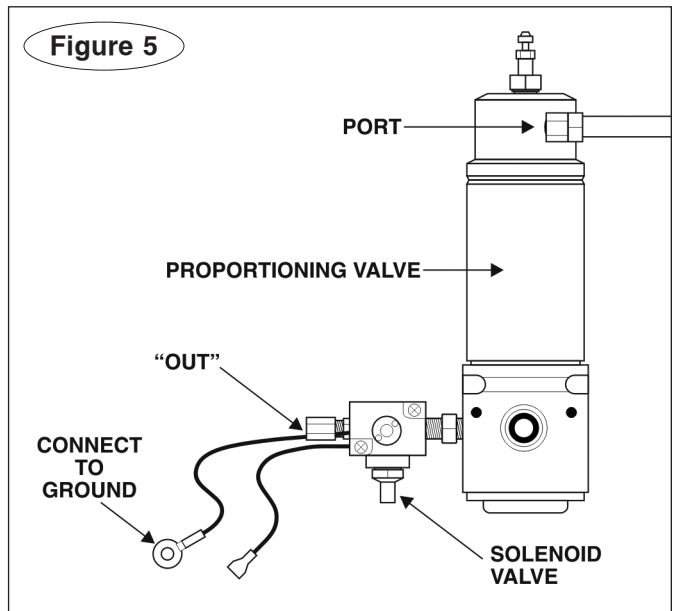

- If there is air at the proportioning valve – follow the air line back to the air cylinder in the towed vehicle. Inspect the entire line for deformities caused by excessive heat and/or kinks in the line, which would restrict the air flow – replace the entire section of air line if any are found.

Disconnect the quick couplers to confirm that they are allowing air to flow through them.

- If there is no air at the proportioning valve – check to confirm that the air line between the air compressor and the proportioning valve is connected to the correct fitting. It should run from the “in” fitting on the air compressor (Figure 6) to the “in” fitting on the proportioning valve (Figure 7).

If the air line is connected to the “out” fitting on the proportioning valve, no air can pass through the valve, and the BrakeMaster system will not function.

continued on next page

Troubleshooting

continued from preceding page

If this is the case, reconnect the line from the air compressor to the "in" fitting on the proportioning valve.

Symptom

The compressor (for motorhomes with hydraulic brakes – BrakeMaster 9060) runs constantly, or runs much more frequently than I think it should.

Solution

1. Check for leaks in the air system.
2. Make certain that the drain valve on the air compressor air tank is closed. Refer to Figure 8.
3. Make certain that a female quick coupler has been installed at the rear of the motorhome – a male quick coupler does not have a check valve to prevent air from escaping.

Symptom

It seems to require a significant amount of brake pressure in the motorhome before the BrakeMaster air cylinder activates in the towed vehicle.

Solution

1. The motorhome engine must be running – if the engine is off, there may be insufficient pressure to activate BrakeMaster.
2. Inspect the air lines for deformities caused by excessive heat and/or kinks in the line, which would restrict the air flow – replace the entire section of air line if any are found.
3. Check for leaks in the air system: after starting the motorhome, allow the air system to fully charge. Depress and hold the motorhome brake pedal down.

Cover each joint, fitting and connection in the air system with a leak check solution.

Tighten any fittings, if necessary, and repeat until all connections are airtight.

4. For motorhomes with hydraulic brakes (BrakeMaster 9060) – If the towing vehicle is a Ford Class C motorhome, the proportioning valve must be teed into the front hydraulic brake line – the rear brake line does not supply sufficient hydraulic pressure.

5. For motorhomes with hydraulic brakes (BrakeMaster 9060) – Not all of the air was bled from the brakes after installing the proportioning valve. Re-bleed the proportioning valve, as well as all brakes (and any components connected to the braking system) downstream from the brake tee. Refer to the complete BrakeMaster installation instructions (at www.roadmasterinc.com) for instructions on bleeding the valve and the brakes.

Symptom

The BrakeMaster air cylinder shaft will extend, and the pedal clamp will depress the towed vehicle's brake pedal. However, the air cylinder shaft will not retract when the motorhome brake pedal is released.

Solution

1. Make certain that the air cylinder has been installed

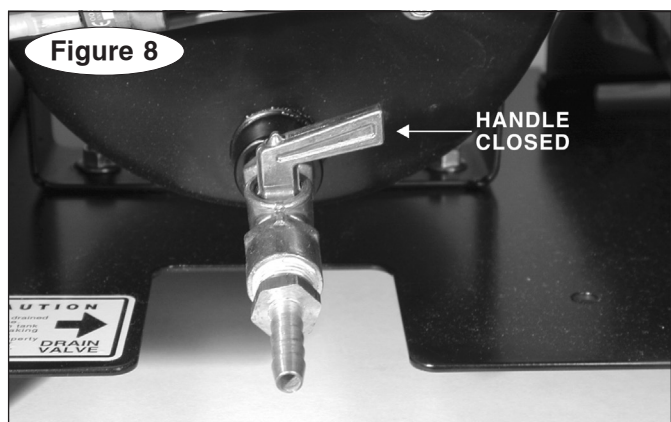
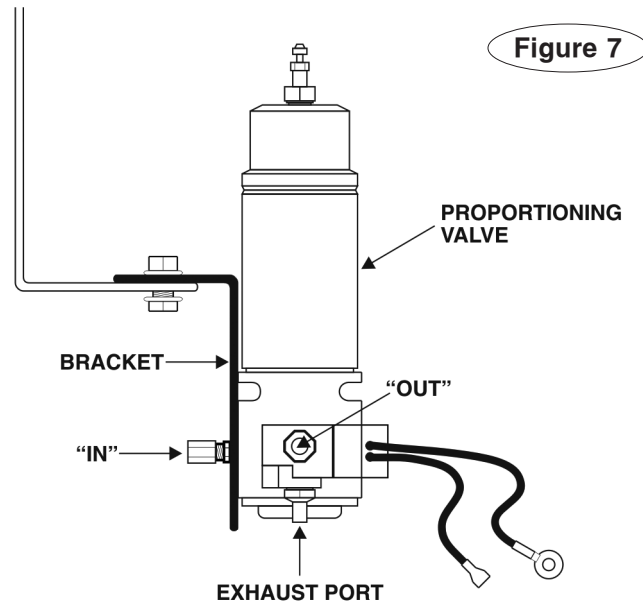

directly in line with the brake pedal. If it is mounted at an angle to the brake pedal (to one side or the other), the air cylinder may jam in the extended position.

2. Dirt or debris can enter the air lines if the weather covers are not used over the quick couplers. It may accumulate at the quick exhaust valve (see page two) on the air cylinder, preventing the valve from venting air out of the air cylinder. Disassemble the quick exhaust valve and make certain it is not jammed.

3. If a system of diodes was used to wire the towed vehicle's lights for towing, make certain that a diode is installed at every point where the motorhome brake light wire connects to the towed vehicle's brake light wire (refer to Figure 4).

When the air cylinder shaft extends and the pedal clamp depresses the towed vehicle's brake pedal, it energizes the towed vehicle's brake light wire. If diodes are not installed in the circuit, current will travel back to the motorhome and activate the BrakeMaster solenoid.

As long as the solenoid is activated, it will not allow air to vent from the air cylinder – the air cylinder shaft will remain extended.

continued on next page

Troubleshooting

continued from preceding page

Symptom

The towed vehicle brakes abruptly the first time BrakeMaster is activated, 'flat-spotting' the tires. Also, after towing, there may be excessive brake dust on the wheels of the towed vehicle, and/or an unusual odor near the towed vehicle's brakes.

Solution

1. The stored vacuum in the towed vehicle's power brake system **must** be depleted before towing – pump the brake pedal several times. Depending on the make and model of the towed vehicle, it may be necessary to pump the brake pedal repeatedly.

Deplete the vacuum in the power brakes every time the towed vehicle's engine has been started – typically, when the vehicle is connected for towing.

The engines in some vehicles, such as the Saturn Vue, must be started periodically during towing. If the towed vehicle's engine must be started periodically, always deplete the vacuum in the vehicle's power brake system **before** you resume towing.

Refer to the caution statement on page 6.

2. If the towed vehicle has an 'active' (or, 'continuous power assist') braking system, order the optional Brake Pressure Reducer (part number 900002) to adapt the vehicle to the BrakeMaster system.

Vehicles with 'active' brake systems include several hybrid vehicles, such as the Ford Escape hybrid and the Mercury Mariner hybrid, as well as the H3 Hummer. These vehicles, and others with 'active' braking systems, are designed so that even when the ignition is turned to the "tow" position, the braking system is still active.

If the Brake Pressure Reducer is not installed, BrakeMaster will apply excessive force to the towed vehicle's brake pedal.

3. If the towed vehicle does not have power brakes, order the optional Brake Pressure Reducer (part number 900002) to adapt the vehicle to the BrakeMaster system. BrakeMaster is designed to work with vehicles that have a power brake system (even though the power brakes are not activated while towing).

If the reducer is not installed, BrakeMaster will apply excessive force to the towed vehicle's brake pedal.

Index

3-to-2 converter – test to determine	
if installed in motorhome	9
‘Active’ braking systems	1
Air cylinder –	
Parts list.....	2
Quick exhaust valve – rotating.....	4
Air lines –	
Check for leaks.....	6
Connecting to the quick couplers	3
Initial installation.....	3-4
Automatic Battery Disconnect –	
when to install	1
Brake light solutions	8
Brake light switch – finding “cold” side.....	5
Brake-Lite Relay –	
determine if the relay must be used.....	8
Brake Pressure Reducer – when to use	1
Combined brake and turn signal	
lights – definition (Figure 3).....	8
Motorhome monitor wiring –	
Initial installation.....	5
Test for proper operation	6
Power brakes – releasing vacuum –	
cautionary statement	6
Safety definitions	inside front cover
Separate brake and turn signal	
lights – definition (Figure 3).....	8
Stop light switch kits –	
determine if stop light switch is required.....	1
Test the system	6-7
Vacuum, power brakes –	
cautionary statement	6
Weather covers.....	4