



U.S. patent number
8,708,369

part number 4700 –
for all ROADMASTER tow bars with quick-disconnect release systems

Assembly and Installation Instructions



Time Tested • Time Proven

ROADMASTER, Inc. • 6110 NE 127th Ave • Vancouver, WA 98682 • 800-669-9690 • Fax 360-735-9300 • www.roadmasterinc.com



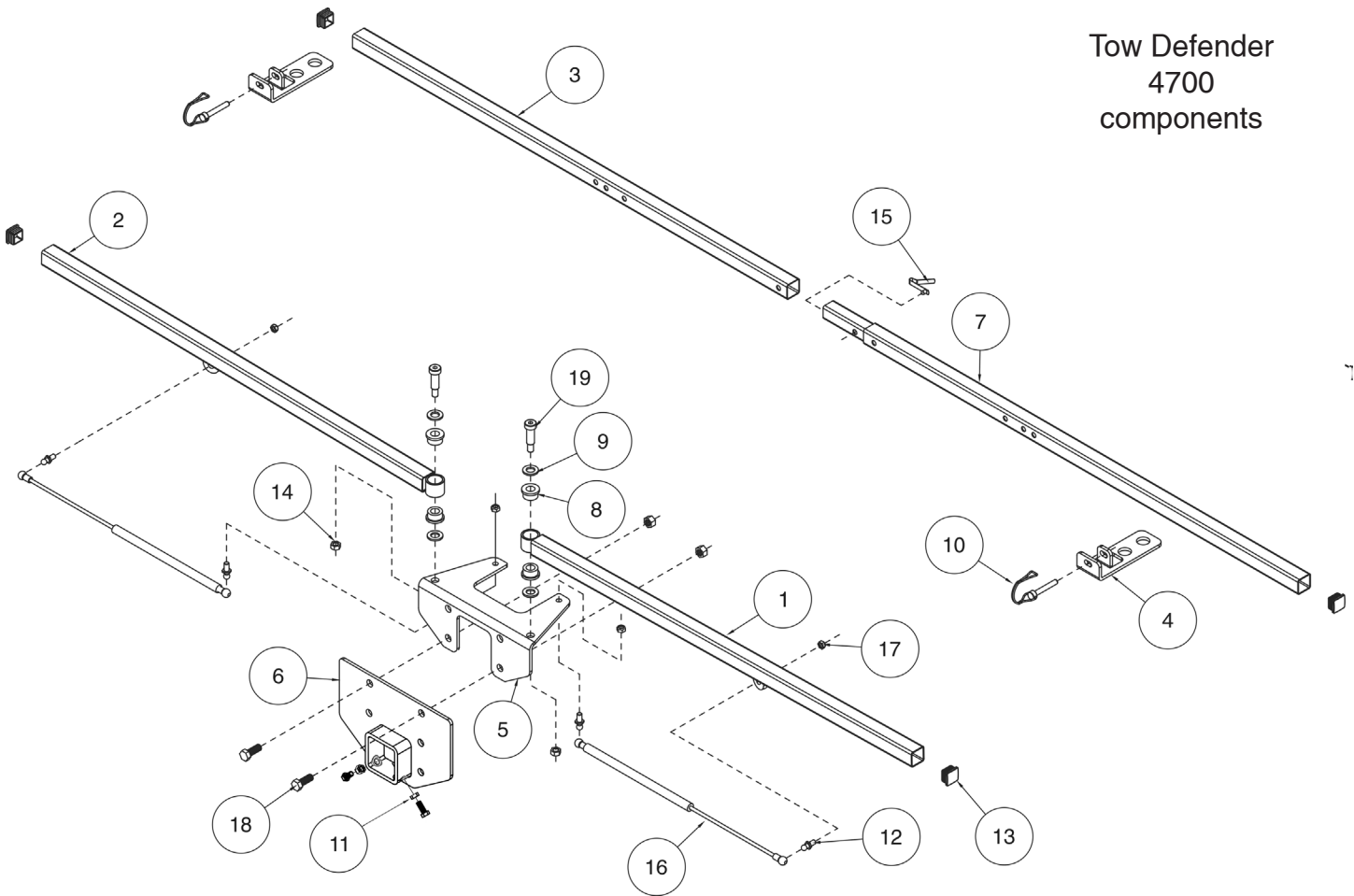

© 2006-2020 ROADMASTER, Inc. All rights reserved.

85-3634-21 06-20

Tow Defender
4700
components



Item	Qty	Name	Part number
1	1	Driver side tube	501301-00
2	1	Passenger side tube	501301-10
3	1	Female tube	A-002641
4	2	Bracket	B-000897
5	1	Main plate	B-001174
6	1	Mounting plate	C-001708
7	1	Male tube	C-001709
8	4	Poly bushing	200375-00
9	4	Flat washer	355720-00
10	2	Safety pin	356997-00
11	2	3/8" jam nut	350254-40
12	4	Ball	200024-00
13	4	Plastic plug	200142-00
14	4	3/8" lock nut	350272-00
15	1	Spring button	200699-00
16	2	Gas spring, overall length: 20½"	200023-50
		Gas spring, overall length: 21"	200023-60
<i>Note: two different gas springs have been used to manufacture the Tow Defender. You must measure to determine the appropriate spring.</i>			
17	4	5/16" lock nut	350253-01
18	4	3/8" X 1" bolt	350055-00
19	2	1/2" x 1 1/4" shoulder bolt	350094-50
20	1	4700 screen	D-000011

collar attachment hardware kit 4800-30	
consists of:	
(2) ½" x 1¼" shoulder bolts	
(4) 3/8" polyurethane bushings	
(4) ½" steel washers	
(2) 3/8" lock nuts	

NOT SHOWN
Tow Defender fabric – part number 4700-10
Velcro straps (set of 2) – part number 4700-2

Description

The Tow Defender's all-weather, heavy-duty screen deflects rocks, gravel and road debris down and away, protecting your towed vehicle's finish, headlights and windshield against chips and dings. The vinyl-coated mesh lets air through, keeping it low and over the road.

Fully extended, the Tow Defender measures 45" by 72" (more than 20 square feet), and is held in place with shock-absorbing steel struts. Adjust the tension to fit your towing system by simply sliding the collar up or down the tow bar stinger or ball hitch mount.

Once you've reached your destination, roll up the Tow Defender, snap the elastic straps around each end, and store it against the motorhome.

The Tow Defender features powder-coated steel supports and heavy-duty gas struts for maximum durability, support and cornering flexibility.

The model 4700 Tow Defender is designed for all ROADMASTER tow bars with quick-disconnect release systems.

Unpacking

After unpacking the Tow Defender, inspect carefully for any damage that may have occurred during transit. Check for loose, missing or damaged parts. Check to be sure all supplied components are enclosed.

In case of questions, damaged or missing parts, please call 800-669-9690 for customer assistance.

IMPORTANT

The Tow Defender is designed to reduce the damage to the vehicle while being towed. Although the Tow Defender will significantly reduce the amount of vehicle damage, the Tow Defender will not eliminate all damage, under all circumstances.

Accordingly, ROADMASTER expressly disallows any and all claims related to rock chips, dings, scratches or any other damage incurred to the towed vehicle.

All illustrations and specifications contained herein are based on the latest information available at the time of publication. ROADMASTER, Inc. reserves the right to make changes, at any time, without notice, in material, specifications and models, or to discontinue models.



Made in the U.S.A.

IMPORTANT NOTICE!

Safety Definitions

These instructions contain information that is very important to know and understand. This information is provided for safety and to prevent equipment problems. To help recognize this information, observe the following symbols:



WARNING

WARNING indicates a potentially hazardous situation which, if not avoided, could result in property damage, serious personal injury or even death.



CAUTION

CAUTION indicates a potentially hazardous situation which, if not avoided, may result in property damage, or minor or moderate personal injury.

CAUTION

CAUTION used without the safety alert symbol indicates a potentially hazardous situation which, if not avoided, may result in property damage.

NOTE

Refers to important information and is placed in italic type. It is recommended that you take special notice of these items.



CAUTION

Read all instructions before installing or using the Tow Defender. Failure to understand how to properly install or use the Tow Defender could result in property damage or personal injury.



Save these instructions

Save these instructions for future reference. They contain important sections relative to safety, use, parts replacement and other information. Therefore, make sure this manual is always with you when you're towing. You may download or print a copy of the most current instructions at www.roadmasterinc.com (under 'Support').

CAUTION – A hitch extension may be required.

Some motorhome chassis have such a tight turning radius that the Tow Defender may contact and cause damage to the motorhome or towed vehicle during sharp turns. For this reason, check the motorhome turning radius before using the Tow Defender for the first time – in an empty parking lot, attach the Tow Defender, then have someone watch as you slowly turn the motorhome sharply.

If the Tow Defender is too near the motorhome,

you must attach a hitch extension to the motorhome hitch receiver in order to use the Tow Defender. This will extend the distance between the motorhome and the Tow Defender.

We recommend our 7½" extension (part number 071-75, pictured above) for this purpose.

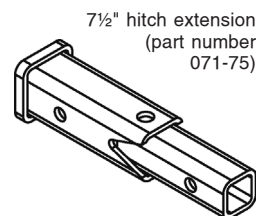

For StowMaster™ or StowMaster All Terrain™ applications only...

CAUTION

To ensure adequate clearance, the coupler on the StowMaster or StowMaster All Terrain tow bar must be mounted on a ball hitch extension with a drop of at least two to four inches.

Otherwise, the coupler will wear through the Tow Defender fabric if, while towing, any portion of the fabric comes into direct contact with the coupler.



WARNING

Do not install a ball hitch extension with a drop for the sole purpose of gaining adequate clearance for the Tow Defender.

The StowMaster tow bar must be approximately level. If the tow bar is not level, it may be damaged during towing, or it may detach from the ball mount.

Refer to the StowMaster owner's manual for additional information.

Failure to follow these instructions may cause property damage, personal injury or even death.

CAUTION

The mesh fabric may be warped or otherwise damaged by the heat from exhausts at the rear of the motorhome. Do not attach the Tow Defender so that the mesh fabric is in close proximity to the engine exhaust pipe.

If the exhaust is located directly below the Tow Defender, install a 'turn down' extension (sold separately) on the engine exhaust (according to the manufacturer's recommendations), to redirect the exhaust away from the fabric. The Tow Defender fabric may be warped or otherwise damaged if a turn down extension is not installed, or if other exhausts which cannot be redirected (recessed exhausts, or exhausts from "hydronic" heating systems) are in close proximity to the fabric.

Under what conditions could heat from exhaust pipes damage the Tow Defender fabric?

1. Heat from the engine exhaust could potentially damage the fabric – the temperature at the engine exhaust pipe can be over 1,000° Fahrenheit, under certain conditions.

Install a "turn down" extension, as instructed above, if the engine exhaust pipe is directly below the Tow Defender.

2. Heat from a "hydronic" heating system exhaust will damage the fabric, if it is directed out the rear of the motorhome, in close proximity to the fabric – the temperature at the exhaust pipe may be between 500° and 600° Fahrenheit.

Many of these systems vent the exhaust at the side of the motorhome. Side-vent exhaust will not damage the Tow Defender fabric – only exhaust which is vented at the back of the motorhome could potentially damage the fabric.

Some manufacturers stipulate that hydronic system exhausts at the rear of the motorhome be directed straight

back (horizontal to the road). The exhaust cannot be directed down, or a fire may result when the motorhome is parked in dry, grassy areas, according to these manufacturers.

Redirecting the exhaust may void the manufacturer's warranty – several manufacturers stipulate a maximum of two 90° bends over the entire length of the exhaust pipe – more than two 90° bends may cause back pressure to destroy the exhaust pipe or force the exhaust back into the heating system.

Redirecting the exhaust at any angle may be ineffective, as far as avoiding damage to the Tow Defender fabric – the exhaust would still be carried back and over (or under) the fabric.

3. Heat from the generator exhaust could potentially damage the fabric – the generator may run when the motorhome is stationary, and the heat may not be dissipated as quickly as it would be if the motorhome was moving.

Similarly, if the motorhome is stationary for an extended period, with the engine idling, the Tow Defender fabric can be damaged by heat from the engine exhaust.

4. Additionally, heat from recessed exhausts (for the furnace and/or water heater) could conceivably cause damage, if they were close enough to the fabric.

5. Heat from the exhaust of other systems, which ROADMASTER is presently unaware of, may also cause damage.

Assembly and connection instructions

1. Unfold the Tow Defender and unroll it, until the fabric is completely flat.

2. Connect one of the gas struts to the collar – pivot the end of one of the gas struts until the cap at the end of the gas strut (Figure 1) is over the ball joint (Figure 1) on that side. Press the cap down onto the ball joint, until it snaps in place.

Repeat to connect the other gas strut.

3. Disconnect the tow bar from the hitch receiver and slide the Tow Defender collar bracket (Figure 2) over the tow bar stinger or ball hitch mount, so that the adjustment bolt (Figure 2) at the bottom of the collar bracket is facing the hitch receiver. Hand-tighten the adjustment bolts to hold the collar in place.

Slide the tow bar stinger or ball hitch mount into the motorhome hitch receiver and reattach it.

4. Attach the collar (and the Tow Defender gas struts and fabric with it) to the collar bracket, using the two 3/8" x 1" bolts and nuts, as shown in Figure 3. Attach the collar at the 'average' setting.

5. Attach the tow bar to the towed vehicle. Also attach the safety cables, electrical cord and any other components which are connected between the two vehicles, according to the manufacturers' instructions

6. **For all motorhome-mounted tow bars** – At both sides of the quick-disconnect (QD) crossbar, remove the QD linch pins (Figure 4) from the pins at the top of both QDs. Then, position the QD adaptor brackets (Figure 4) over the pins at the top of the QDs and replace and lock the QD linch pins, as shown in Figure 4.

For StowMaster and StowMaster All Terrain tow bars – the attachment method is the same as above, but the linch pins attach through the holes at the end of the QD adaptor brackets. Refer to Figure 6.

Note: to use the Guardian™ rock shield with the Tow Defender – If the Guardian rock shield is to be used with the Tow Defender, connect the Tow Defender first. Then attach the Guardian, according to the instructions included with the Guardian.

For motorhome-mounted tow bars – use the holes at the end of the QD adaptor brackets to attach the Tow Defender (identified as "attachment for Tow Defender with Guardian")

continued on next page

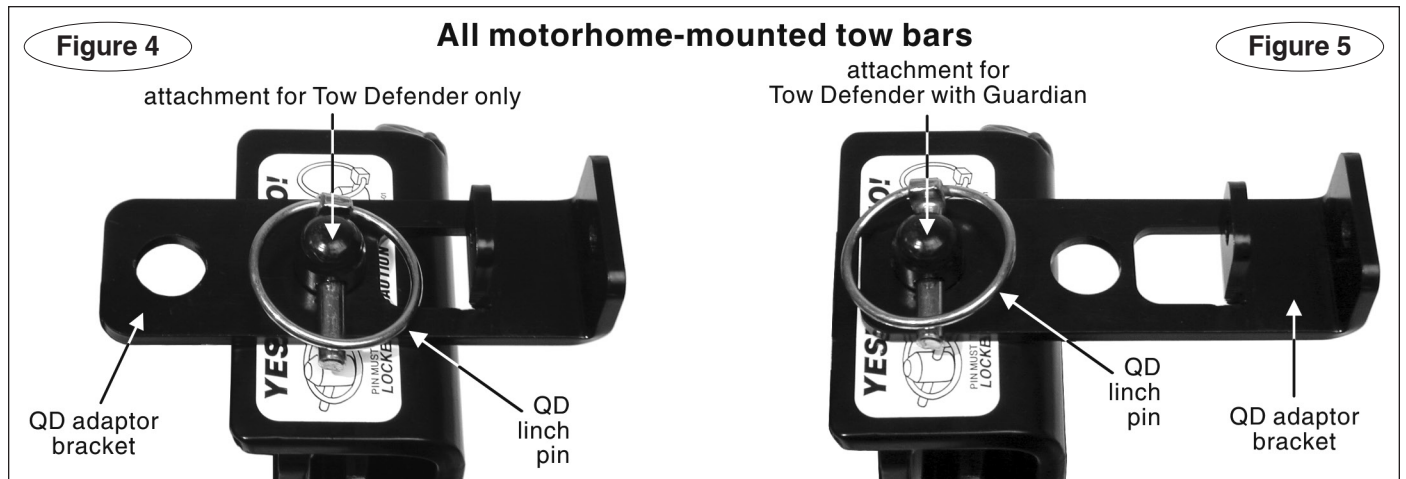
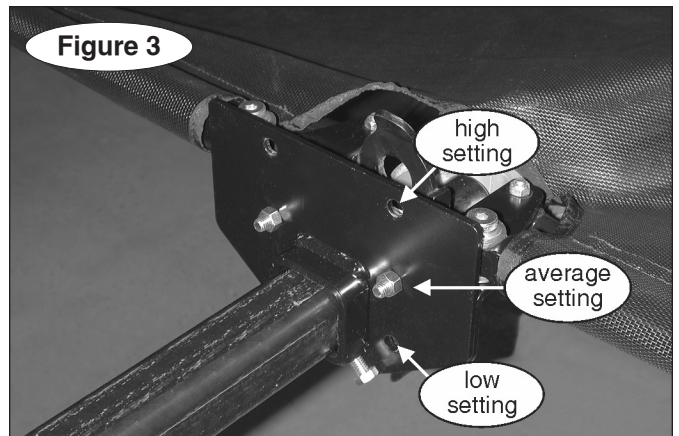
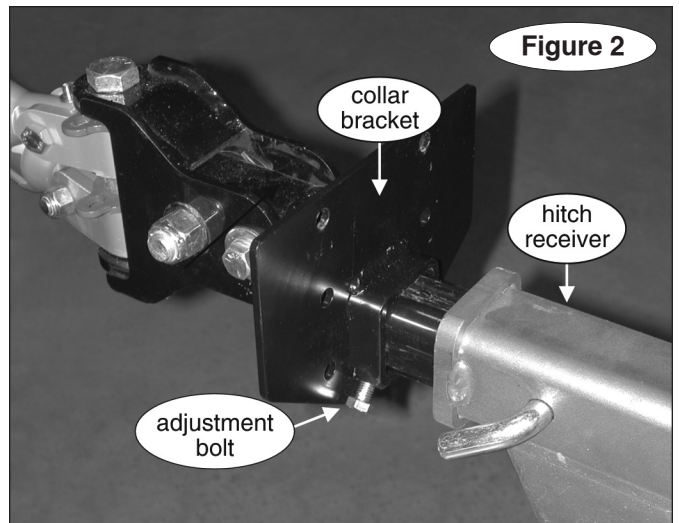
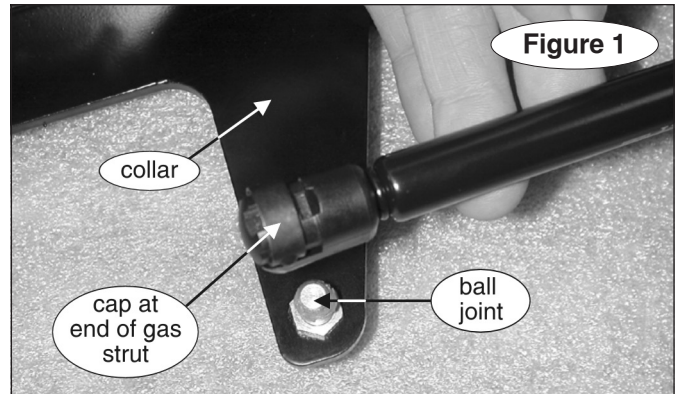

continued from preceding page
Guardian" in Figure 5).

For StowMaster and StowMaster All Terrain tow bars – always use the holes at the ends of the QD adaptor brackets to attach the Tow Defender, regardless of whether or not the Guardian rock shield will also be attached. See Figure 6.

WARNING

Make certain that the QD lynch pins at both of the adaptor brackets are properly attached. If the QD lynch pins are not locked into position, with the curved side of the lynch pins touching the rings, towing vibrations will force the QD lynch pins out, which will cause the tow bar to separate from the towed vehicle. If safety cables are not present, the towed vehicle will separate from the motorhome, which will cause property damage, personal injury or even death.

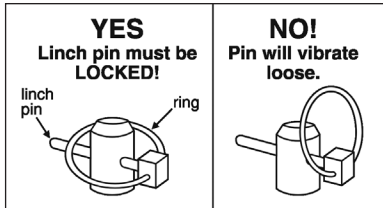

7. Now, connect the car-side support bars to the other side of the Tow Defender – one of the support bars has a pre-drilled hole near one end; the other has a push-button lock. Slide both of the support bars through the center of the Tow Defender and into the pocket at the edge of the screen (Figure 7), so that the hole and the push-button lock are at the center. Then, depress the push-button lock and slide the bars together, until the lock snaps through the hole (Figure 7).

8. Unfold the Tow Defender until the support bars are over both QD adaptor brackets (Figure 8). Rotate the support bars, if necessary, so that the pre-drilled holes in the support bars align to the pre-drilled holes in the QD adaptor brackets. Then fit the support bars into the slots in the adaptor brackets, as shown in Figure 8. Next, insert the two safety pins (Figure 8) through the pre-drilled holes in the support bars and the QD adaptor brackets, and lock them in place, as shown in Figure 8.

Note: the safety pins can only be attached with the open end facing the towed vehicle, as shown in Figure 8.

CAUTION

If the safety pins are not locked in place as shown in Figure 8, the Tow Defender will separate from the towed vehicle, which may cause significant damage to the towed vehicle or the Tow Defender.

9. Now that the Tow Defender is connected, make certain that the tow bar can be stored at the back of the motorhome – without removing the support tubes, roll the screen toward the motorhome, and secure the Tow Defender with the Velcro storage straps (Figure 9) around each side of the Tow Defender. Then disconnect the tow bar and fold it against the side of the motorhome.

If the Tow Defender interferes with the storage of

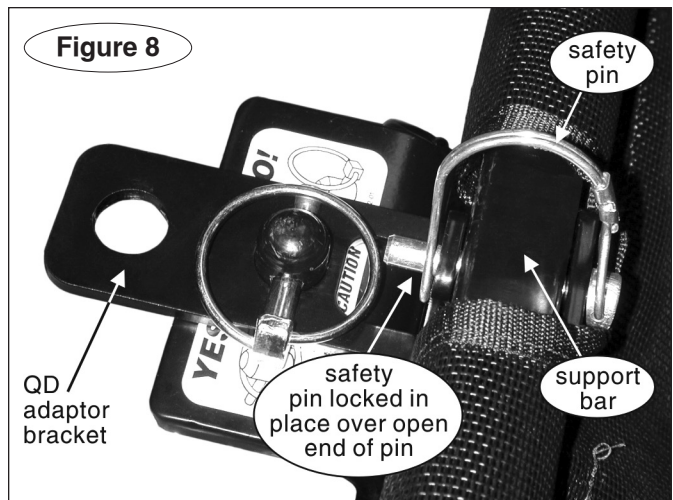
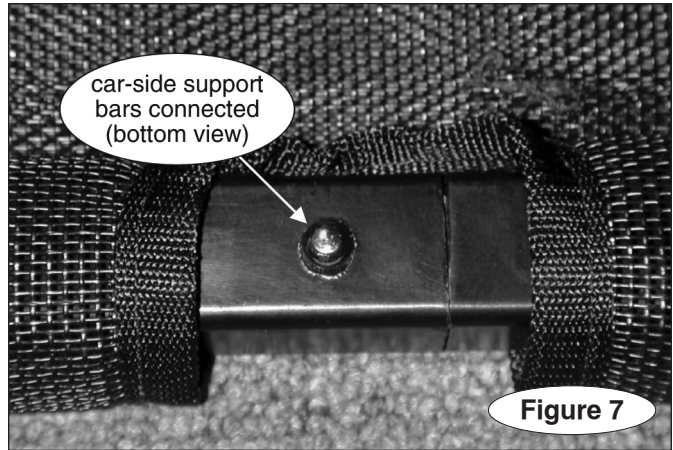
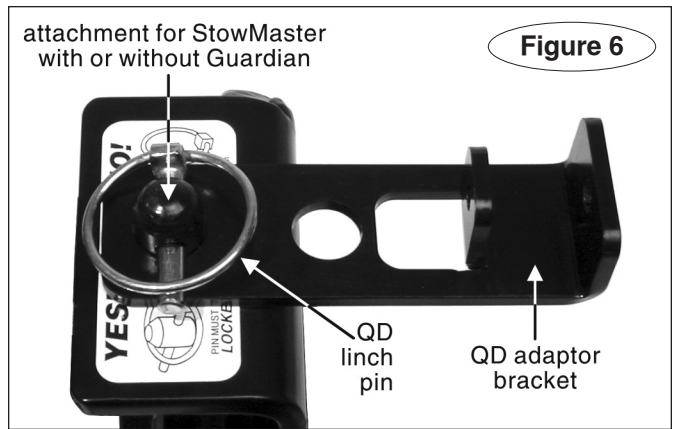

the tow bar, adjust the collar and/or the collar bracket to gain clearance.

10. Now that you have verified that the tow bar can fold up for storage, it may be necessary to adjust the Tow Defender to your towing system. The fabric must be taut enough to deflect road debris away from your towed vehicle. However, if it is stretched too tight, the fabric will fail and tear at the seams over time.

If necessary, refer to the table on page five to adjust the fabric.

11. IMPORTANT! The last adjustment you make must be as follows: slide the Tow Defender collar bracket (Figure 2) up or down the tow bar stinger (or hitch ball exten-

continued on next page

continued from previous page

sion), so that the Tow Defender screen appears taut. Now slide the collar bracket back one inch toward the towed vehicle. **This slack is necessary for sharp turns.** If the fabric is too taut, over time the fabric will fail and tear at the seams.

CAUTION

Failure to leave enough slack in the screen will cause the fabric to tear and is not covered by warranty.

12. With the collar in the correct position, tighten the adjustment bolt at the bottom of the collar (Figure 9) with a 9/16" wrench, until the collar is fixed in place, then secure the jam nut.

13. When not in use, the Tow Defender may be stored at the rear of the motorhome – remove the QD adaptor safety pins and both of the QD adaptor brackets, roll the screen toward the motorhome, and loop and attach one of the two storage straps around each side of the Tow Defender (Figure 9).

CAUTION

Remove both of the QD adaptor brackets when the Tow Defender is not in use. If the Tow Defender is not attached to them, the brackets may rotate out of position and damage the towed vehicle's finish.

CAUTION

When the motorhome is stationary with the engine idling, the Tow Defender fabric can be warped or otherwise damaged by the heat from exhaust systems at the rear of the motorhome. Do not idle the motorhome engine for an extended period when the Tow Defender is attached to the motorhome, or non-warranty damage



CAUTION

Do not lift or carry the Tow Defender by the safety pins. The pins will separate and the Tow Defender will fall, which may cause property damage or personal injury.



WARNING

The Tow Defender fabric may conceal the towing system attachment points, as well as the attachment points for other components underneath it. Before towing, make certain that the tow bar, safety cables, electrical cord and any other components which are underneath the Tow Defender are securely attached, according to the manufacturers' instructions.

If a component of the towing system, or any other component underneath the Tow Defender, has detached and is not reattached, the towing system or other components may fail, which may cause property damage, personal injury or even death.

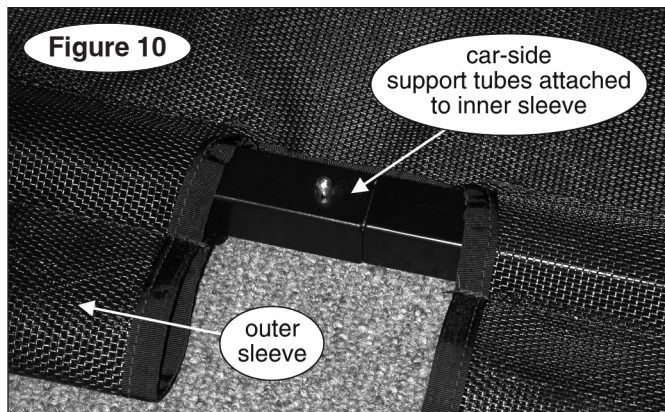
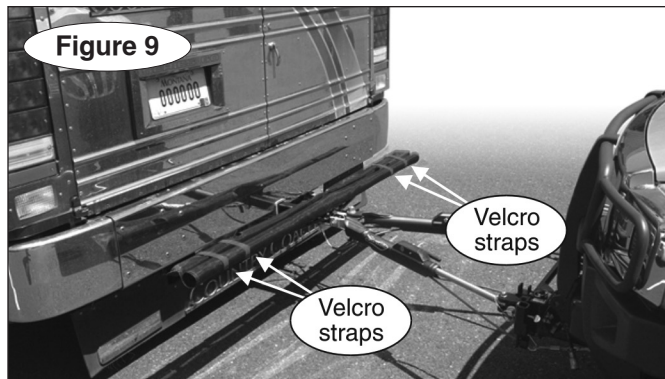

Adjustments to the Tow Defender fabric

If the fabric is too tight...

- Move the collar bracket toward the towed vehicle, or...
- Move the support tubes to the outer sleeve (Figure 10).

If the fabric is too loose...

- Move the collar bracket toward the motorhome, or...
- Move the support tubes to the inner sleeve (Figure 10), or...
- Bolt the collar on the other side of the collar mounting bracket, or...

If the motorhome exhaust pipe is too close to the fabric...

- Bolt the collar to a different height setting (Figure 3), or...
- Move the collar bracket toward the towed vehicle.

CAUTION

If the fabric cannot be adjusted away from the exhaust pipe, do not use the Tow Defender – non-warranty damage to the fabric will occur.

WHY FIGHT IT?

Does your suspension have the best of you?...beat you down?...control you?

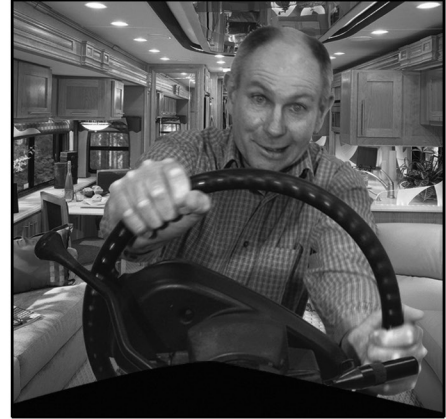

Driving your truck or RV should be an enjoyable experience. And it can be. Adding a set of RSS anti-sway bars to your suspension has an immediate effect on stability and cornering control (especially with towing combinations) — the vehicle stays level, even through the turns.

An RSS bar anchors the frame to the axle, so that the pressure shifts caused by crosswinds or cornering are virtually eliminated. The anti-sway bar does all the fighting — instead of you — so even after hours at the wheel, you arrive fresh, instead of fatigued.

So what are you waiting for? It's time to relax, and enjoy the ride.

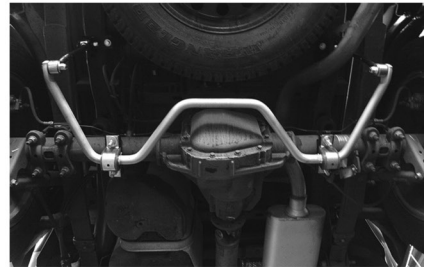
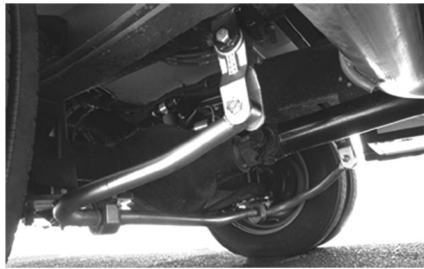

RSS anti-sway bar benefits

Improved handling • Increased stability • A safer, smoother ride • Reduced body roll • Combats crosswinds
Corner with confidence • Less driver fatigue • Improvement over factory standard equipment

Designed to fit specific

Class A Motorhomes • Class C Motorhomes • Sport Utility Vehicles • Trucks • Vans



ROADMASTER
SUSPENSION SOLUTIONS



www.roadmasterinc.com
800-669-9690